

TX-5050RGL20VCD1-NG4AA-01

PRODUCT SPECIFICATION

Features:

- ◆ Excellent transiting heat from LED chip operating under RGL:1.5A
- ◆ High luminous output
- ◆ No UV
- ◆ Encapsulated materials are environmentally certified and meet environmental requirements.

Moisture Proof Grade:

- ◆ LEVEL1

Emitting Color:

- ◆ Red(R)
- ◆ Green(G)
- ◆ Blue(B)
- ◆ Lime(L)

Applications:

- ◆ Auxiliary lighting
- ◆ Ambient lighting
- ◆ Architectural lighting
- ◆ Entertainment lighting

Part No.	TX-5050RGL20VCD1-NG4AA-01	Spec No.	WKF-EG0054	Page	1 of 10
----------	---------------------------	----------	------------	------	---------

Package Dimensions:

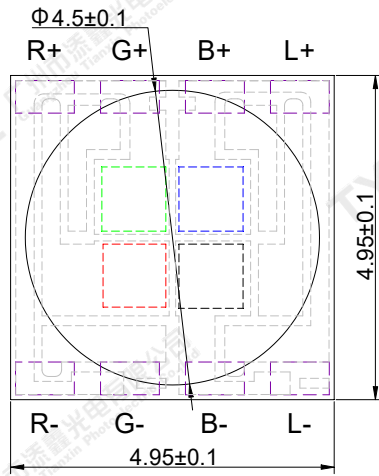

Top view

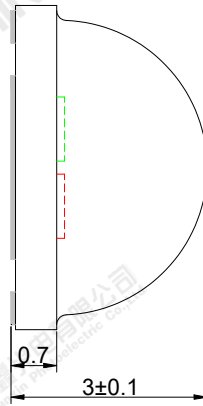

Side view

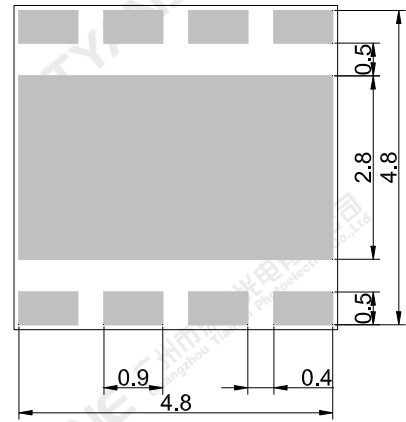

Bottom view

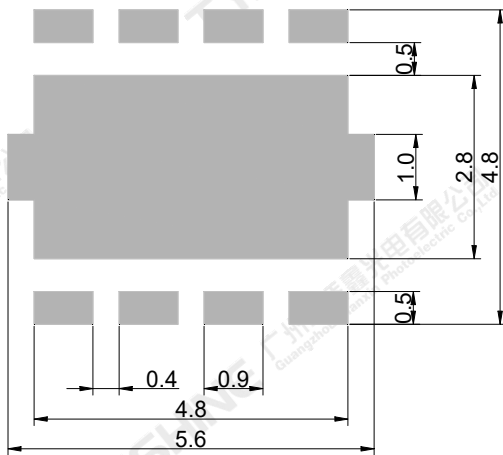

Recommended solder pad

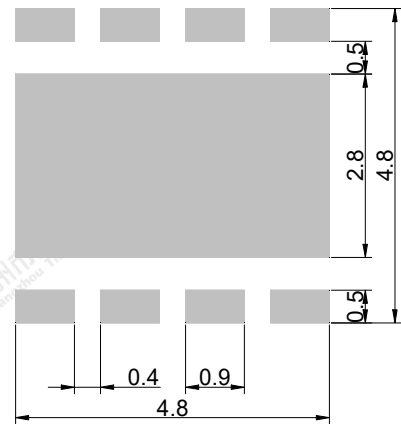

Recommended stencil pattern

Notes:

- 1.All dimensions are in millimeters .
- 2.Tolerances unless otherwise mentioned are ± 0.1 mm .

Part No.	TX-5050RGLB20VCD1-NG4AA-01	Spec No.	WKF-EG0054	Page	2 of 10
----------	----------------------------	----------	------------	------	---------

Absolute Maximum Ratings (Tc=25°C)

Parameter	Symbol	Max Ratings	Unit	
Forward Current	IF	1.5	A	
Peak Forward Current (Condition 1)	IFP	1.8		
Reverse Voltage	VR	5	V	
Power Dissipation	PD	R	4.86	W
		G	5.85	
		B	5.85	
		L	5.85	
Junction Temperature	Tj	R	115	°C
		G	150	
		B	150	
		L	150	
Electrostatic Discharge Threshold (ESD)	ESD	2000	V	
Storage Temperature	Tstg	-40~70	°C	
Operation Temperature	Topr	-30~85		
Ceramic side temperature(Notes 4)	Tcs	85		

Condition 1.Pulse width ≤0.1 msec, duty ≤1/10.

Notes:

- Specifications are subject to change without notice.
- The data on this specification is for reference only and the actual data is in accordance with the acknowledgment.
- Precautions for ESD:
STATIC SHIELD Electricity and surge damages the LED. It is recommended to use a wrist band or anti-electrostatic glove when handling the LED. All devices, equipment and machinery must be properly grounded.
- Temperature on the side of the ceramic substrate near the heat sink.

Part No.	TX-5050RGL20VCD1-NG4AA-01	Spec No.	WKF-EG0054	Page	3 of 10
----------	---------------------------	----------	------------	------	---------

Electrical Optical Characteristics (Tc=25°C,IF=0.7A)

Parameter	Symbol	Emitting Color	Min.	Typ.	Max.	Units
Luminous Flux	Φ_v	R	115	135	150	lm
		G	205	225	245	
		B	30	35	40	
		L	245	260	275	
Dominant Wavelength	λ_d	R	618	622	626	nm
		G	519	522	526	
		B	449	453	456	
Peak-emission Wavelength	λ_p	R	626	630	634	nm
		G	516	519	523	
		B	445	449	452	
Spectral Line Half-Width	$\Delta\lambda$	R	13	16	19	nm
		G	29	34	39	
		B	21	26	31	
		L	100	115	130	
Forward Voltage	V_f	R	2.1	2.5	2.7	V
		G	3.0	3.5	3.7	
		B	3.0	3.4	3.7	
		L	3.0	3.4	3.7	
Correlated Colour Temperature	CCT	L	3850	3925	4000	K
Reverse Current	I_R	VR=5V	—	—	2	μA
Viewing Angle at 50 % IV	$2\theta_{1/2}$	—	—	120	—	Deg
Thermal Resistance Junction to Case	$R\theta_{J-C}$	R	—	3.8	—	K/W
		G	—	4.9	—	
		B	—	4.9	—	
		L	—	3.2	—	
		Total thermal resistance	—	0.8	—	
Temperature Coefficient of Voltage	$V\Delta F/T$	R	—	-1	—	mV/°C
		G	—	-4.9	—	
		B	—	-2.5	—	
		L	—	-1.9	—	

Notes:

1.Luminous intensity is measured with a light sensor and filter combination that approximates the CIE eye-response curve.

- 2. $\theta_{1/2}$ is the off-axis angle at which the luminous intensity is half the axial luminous intensity.
- 3. Luminous flux measurement tolerance: $\pm 10\%$.
- 4. Forward voltage measurement tolerance: $\pm 10\%V$.
- 5. Ra measurement tolerance: ± 2 .

White light Color coordinate filing (IF=0.7A)

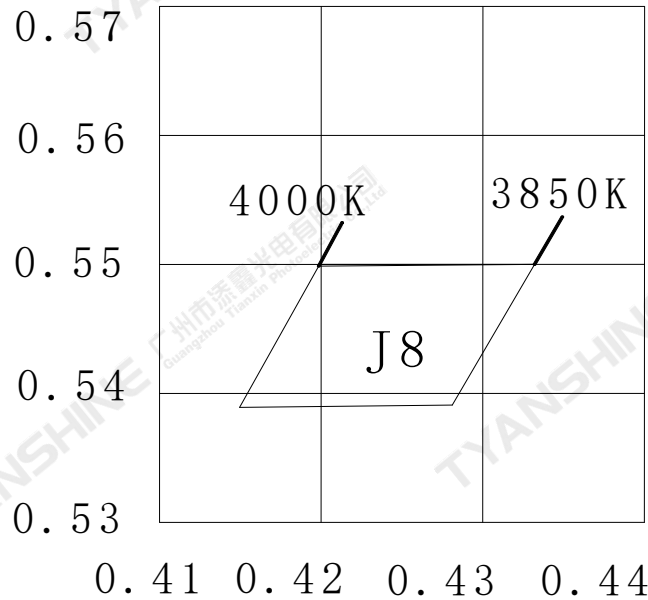

Region	CCT Range		X1	Y1	X2	Y2	X3	Y3	X4	Y4
	Min	Max								
J8	3850K	4000K	0.4281	0.5391	0.4149	0.5389	0.4198	0.5499	0.4332	0.5500

Typical Electrical/Optical Characteristics Curves

(25°C Ambient Temperature Unless Otherwise Noted)

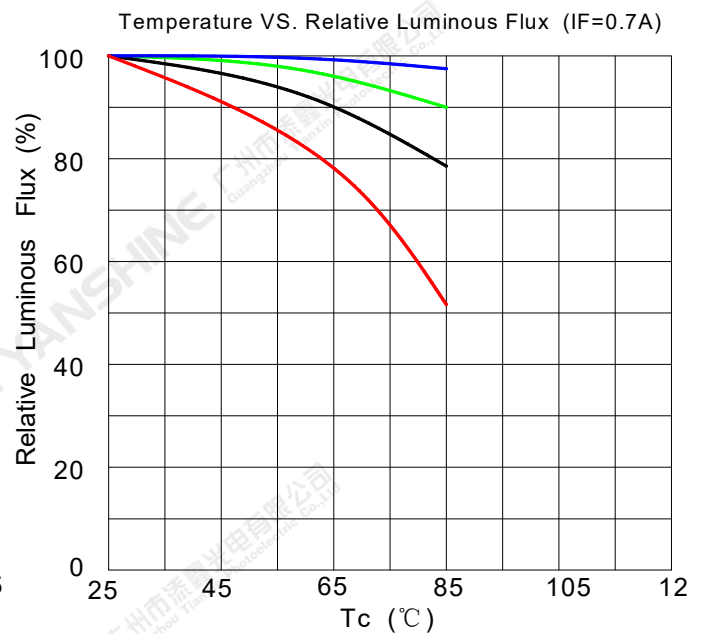
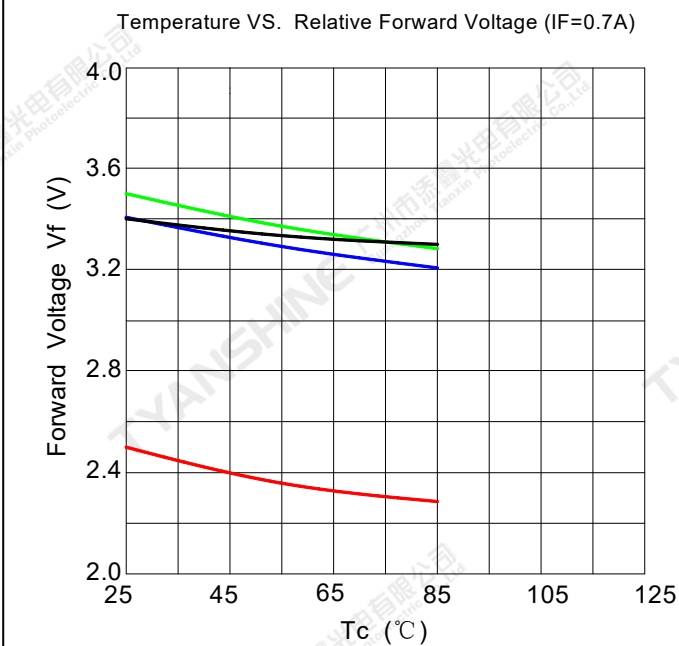
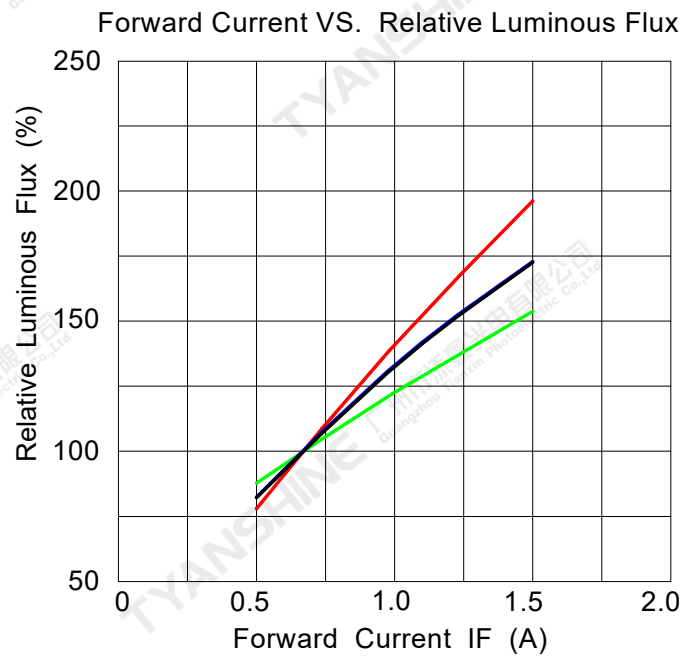
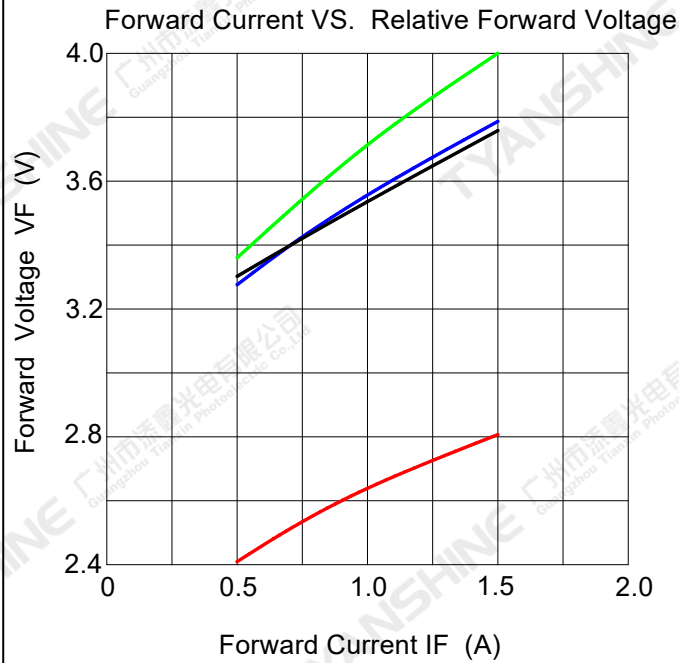

Notes: — Red (R) ; — Green (G) ; — Blue (B) ; — Lime (L) ;

Relative Chromaticity VS. Current

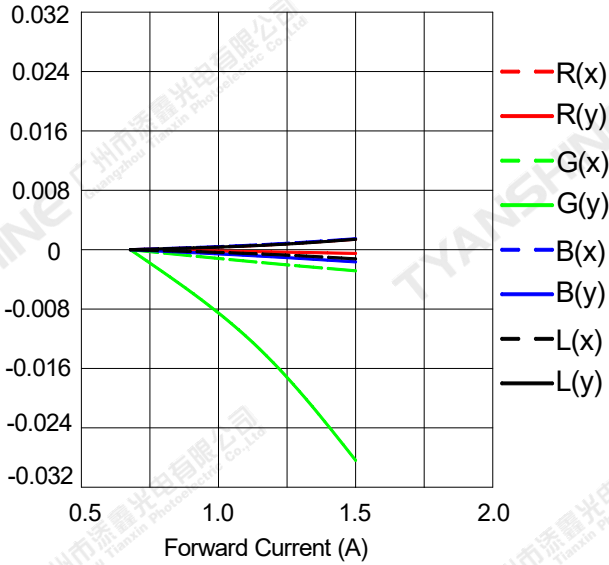

Relative Chromaticity VS. Temperature (IF=0.7A)

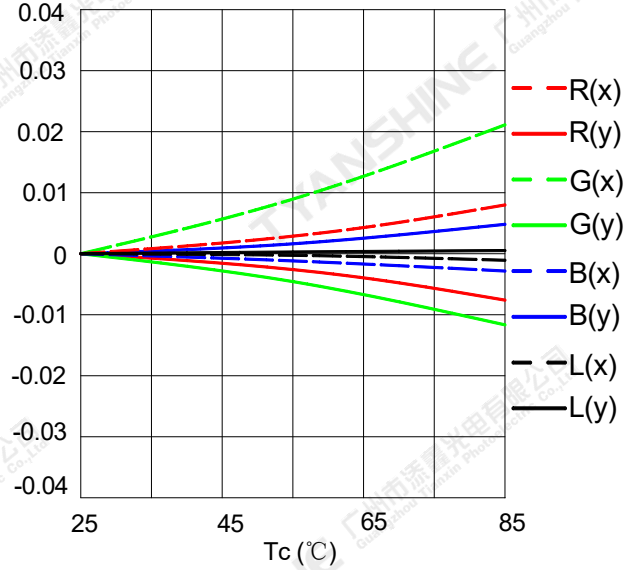

Notes: — Red (R) ; — Green (G) ; — Blue (B) ; — Lime (L) ;

Relative Spectral Distribution

Spectral Radiance: Red Peak@631nm Green Peak@518nm Blue Peak@449nm

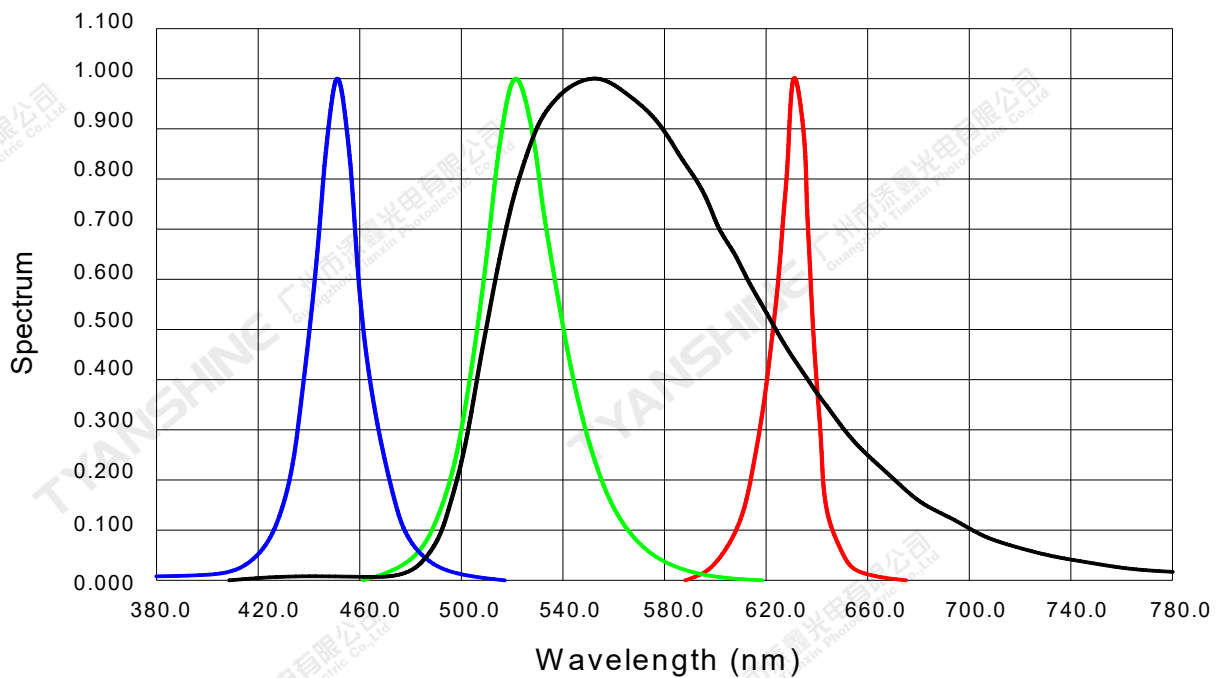

Notes:

1. $2\theta_{1/2}$ is the off axis angle from lamp centerline where the luminous intensity is 1/2 of the peak value.
2. View angle tolerance is $\pm 5^\circ$.

Part No.	TX-5050RGL20VCD1-NG4AA-01	Spec No.	WKF-EG0054	Page	7 of 10
----------	---------------------------	----------	------------	------	---------

Usage Precautions

Storage Environment Condition

Temperature: 5°C ~ 30°C (41°F ~ 86°F)

Humidity: 60% RH Max.

Soldering Condition

Use the conditions shown to the under figure.

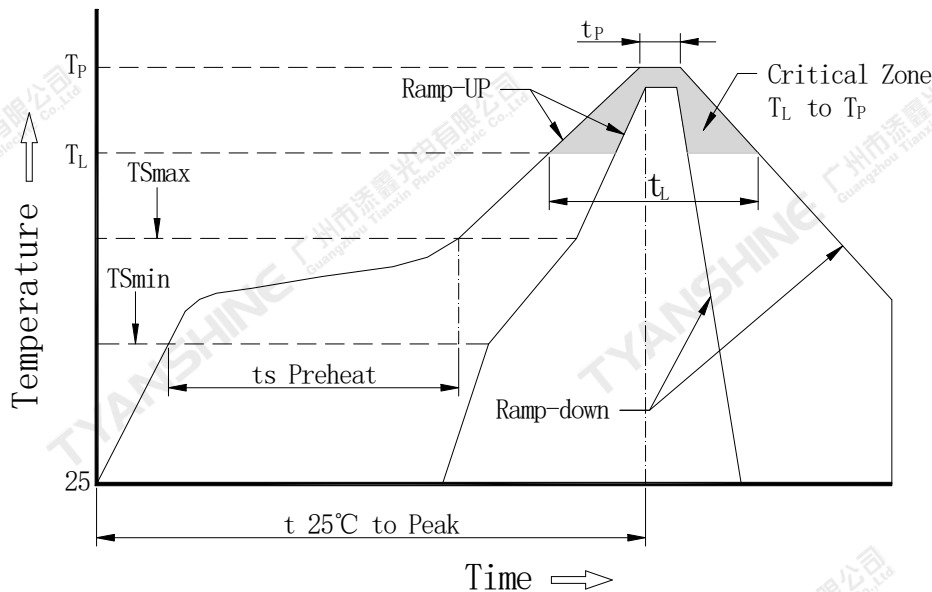

Profile Feature	Pb-Free Solderr(SnBi35Ag0.3)
Average Ramp-Up Rate (TSmax to TP)	3°C/second max.
Preheat: Temperature Min (TSmin)	130°C
Preheat: Temperature Max (TSmax)	190°C
Preheat: Time (TSmin to TSmax)	120-180 seconds
Time Maintained Above: Temperature (TL)	230°C
Time Maintained Above: Time (TL)	60-150 seconds
Peak/Classification Temperature (TP)	255°C
Time Within 5°C of Actual Peak Temperature (TP)	10-35 seconds
Ramp-Down Rate	5°C/second max.
Time 25°C to Peak Temperature	7 minutes max.

Note:

All temperatures refer to topside of the package, measured on the package body surface.

Dimensions For Cannulation And Packaging

Quantity: 500PCS

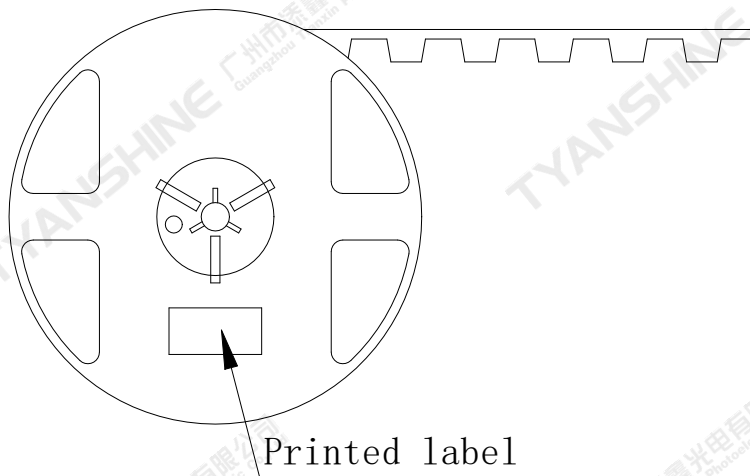
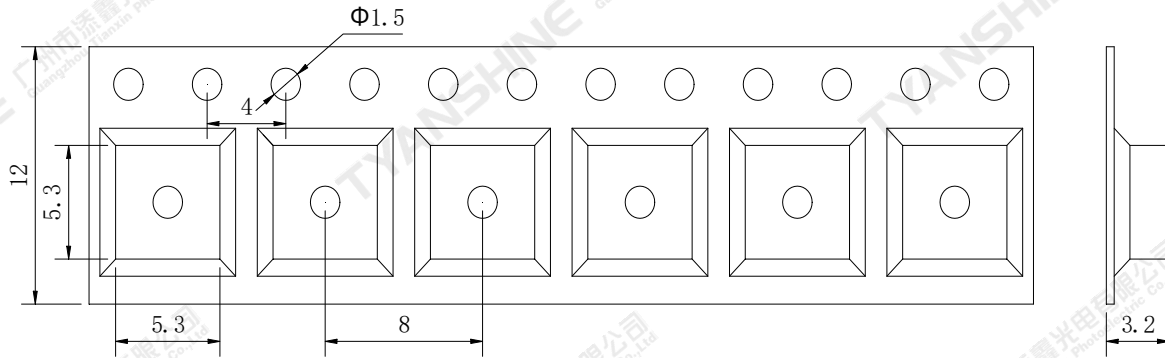

Notes:

1. All dimensions are in millimeters.
2. Tolerances are ± 2.0 mm unless otherwise noted.
3. The products are packaged together with silica gel, Transport, not to the weight of welding LED light-emitting area, As a result of the weight of LED light-emitting zone in the quality of, Irresponsible of the Company.

Part No.	TX-5050RGLB20VCD1-NG4AA-01	Spec No.	WKF-EG0054	Page	9 of 10
----------	----------------------------	----------	------------	------	---------

