

TX-5050RGBL10FC120-NGVCND34-02B

PRODUCT SPECIFICATION

Features:

- ◆ Excellent transiting heat from LED chip operating under 1A
- ◆ High luminous output
- ◆ No UV
- ◆ Encapsulated materials are environmentally certified and meet environmental requirements.

Moisture Proof Grade:

- ◆ LEVEL1

Emitting Color:

- ◆ Red(R)
- ◆ Green(G)
- ◆ Blue(B)
- ◆ Lime(L)

Applications:

- ◆ Auxiliary lighting
- ◆ Ambient lighting
- ◆ Architectural lighting

Package Dimensions:

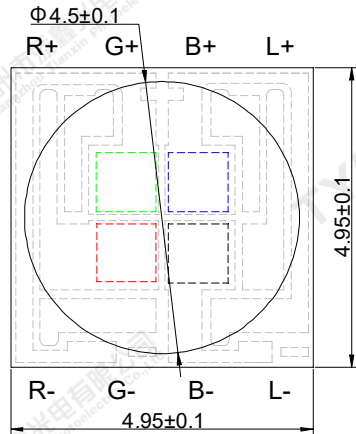

Top view

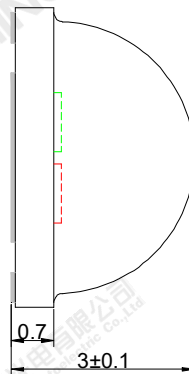

Side view

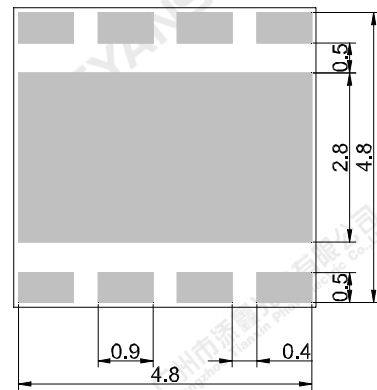

Bottom view

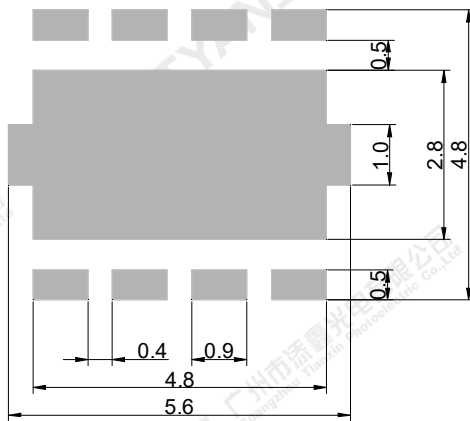

Recommended solder pad

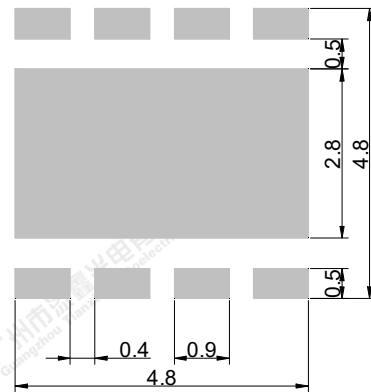

Recommended stencil pattern

Notes:

1. All dimensions are in millimeters .
2. Tolerances unless otherwise mentioned are ± 0.1 mm .

Absolute Maximum Ratings (Tc=25°C)

Parameter	Symbol	Max Ratings	Unit
Forward Current	R	1.0	A
	G	1.0	
	B	1.0	
	L	1.0	
Reverse Voltage	V _R	5	V
Power Dissipation	R	2.7	W
	G	3.7	
	B	3.7	
	L	3.7	
Junction Temperature	R	115	°C
	G	150	
	B	150	
	L	150	
Electrostatic Discharge Threshold (ESD)	ESD	2000	V
Storage Temperature	T _{stg}	-40~70	°C
Operation Temperature	T _{opr}	-30~85	
Ceramic side temperature(notes 4)	T _{cs}	85	

Notes:

- Specifications are subject to change without notice.
- The data on this specification is for reference only and the actual data is in accordance with the acknowledgment.
- Precautions for ESD:
STATIC SHIELD Electricity and surge damages the LED. It is recommended to use a wrist band or anti-electrostatic glove when handling the LED. All devices, equipment and machinery must be properly grounded.
- Temperature on the side of the ceramic substrate near the heat sink.

Electrical Optical Characteristics (Tc=25°C,IF=0.7A)

Parameter	Symbol	Emitting Color	Min.	Typ.	Max.	Units
Luminous Flux	ϕ_v	R	115	130	145	lm
		G	205	230	255	
		B	34	42	50	
		L	200	230	270	
Dominant Wavelength	λ_d	R	620	625	630	nm
		G	520	525	530	
		B	450	455	460	
Correlated Colour Temperature	CCT	L	3850	3980	4000	K
Peak-emission Wavelength	λ_p	R	628	632	635	nm
		G	510	515	520	
		B	448	451	455	
Spectral Line Half-Width	$\Delta\lambda$	R	10	15	20	nm
		G	30	35	40	
		B	15	20	25	
		L	103	108	113	
Forward Voltage	V_f	R	2.1	2.3	2.7	V
		G	3.1	3.3	3.7	
		B	3.1	3.3	3.7	
		L	3.1	3.3	3.7	
Reverse Current	I_R	$V_R=5V$	—	—	2	μA
Viewing Angle at 50 % IV	$2\theta_{1/2}$	—	—	120	—	Deg
Thermal Resistance Junction to Case	$R_{\theta J-C}$	R	—	3.7	—	K/W
		G	—	3.7	—	
		B	—	3.7	—	
		L	—	3.7	—	
Temperature Coefficient of Voltage	$V\Delta F/T$	R	—	-2	—	mV/°C
		G	—	-2	—	
		B	—	-2	—	
		L	—	-2	—	

Notes:

- Luminous intensity is measured with a light sensor and filter combination that approximates the CIE eye-response curve.
- $\theta_{1/2}$ is the off-axis angle at which the luminous intensity is half the axial luminous intensity.
- Luminous flux measurement tolerance:±10%.

4.Forward voltage measurement tolerance:±10%V.

5.Ra measurement tolerance:±2.

White light Color coordinate filing (Tc=25℃,IF=0.7A)

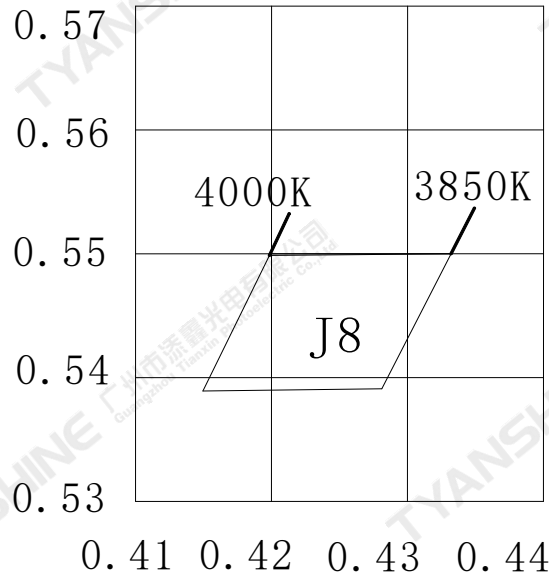

Lemon light Color coordinate filing (Tc=25℃,IF=0.7A)

Region	CCT Range		X1	Y1	X2	Y2	X3	Y3	X4	Y4
	Min	Max								
J8	3850K	4000K	0.4281	0.5391	0.4149	0.5389	0.4198	0.5499	0.4332	0.5500

Typical Electrical/Optical Characteristics Curves

(25°C Ambient Temperature Unless Otherwise Noted)

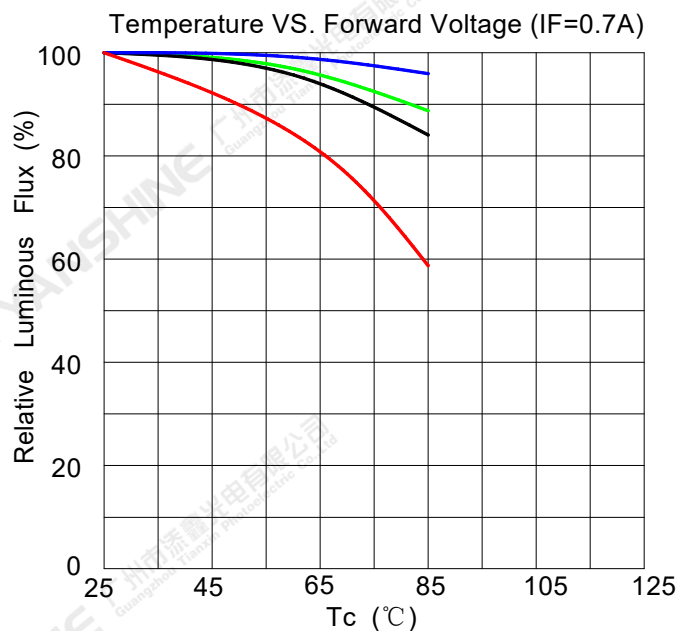
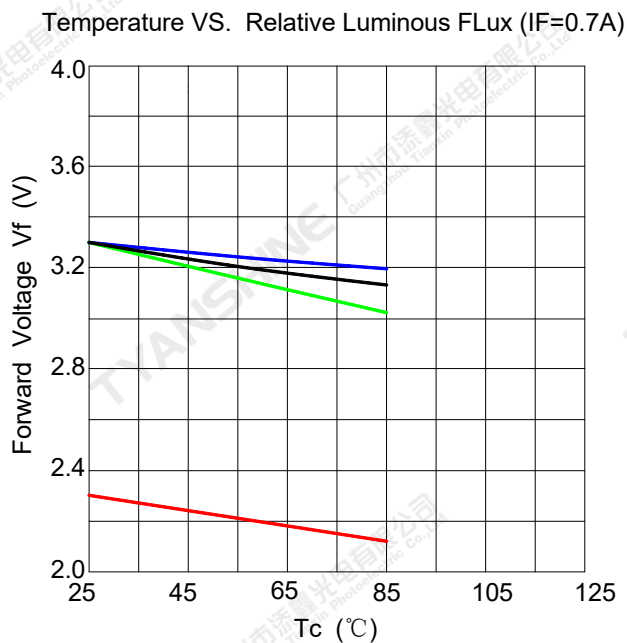
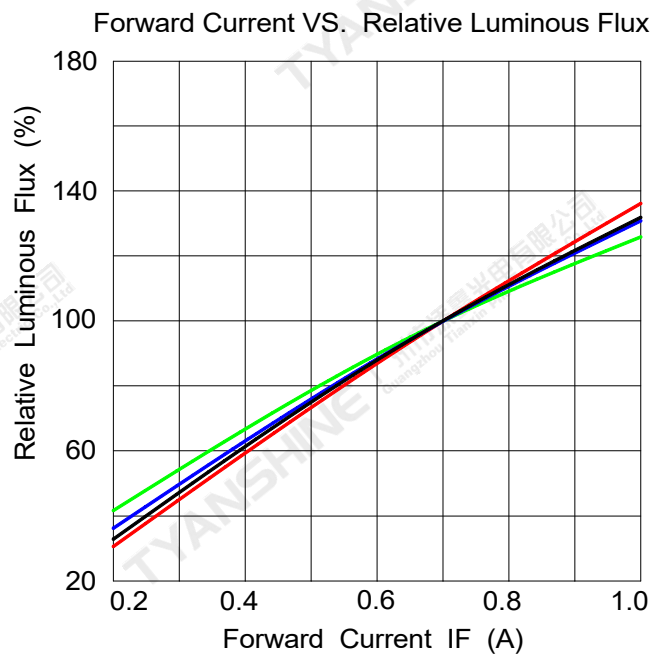
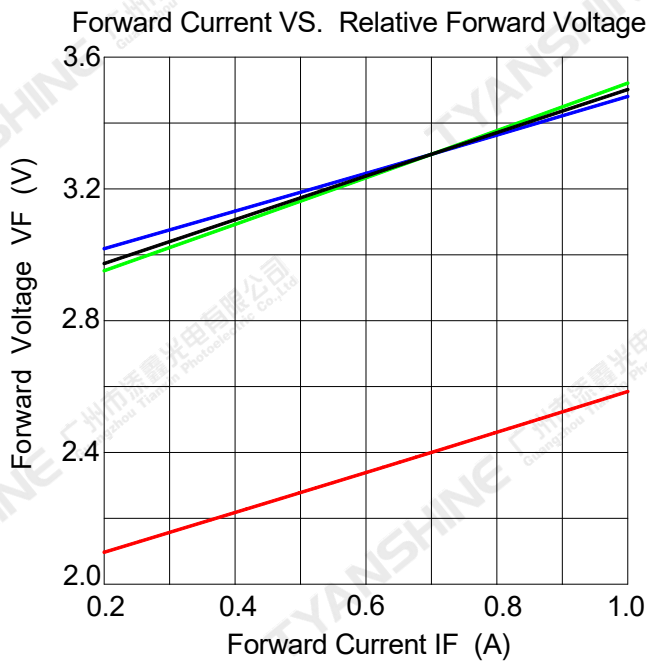

Notes: — Red (R) ; — Green (G) ; — Blue (B) ; — Lime (L) ;

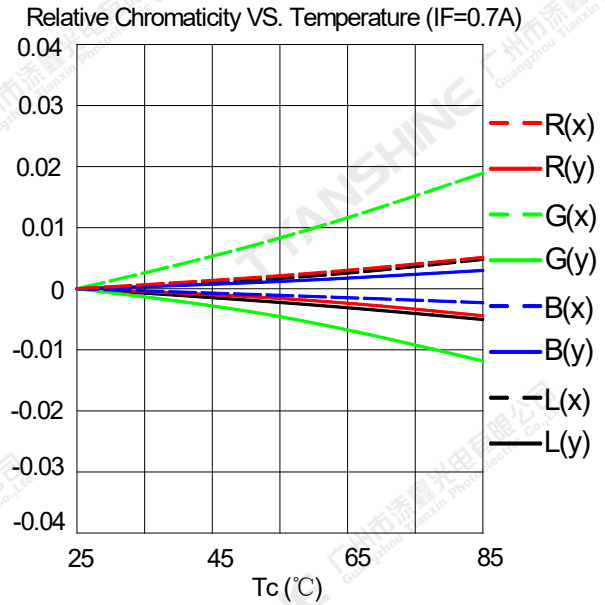
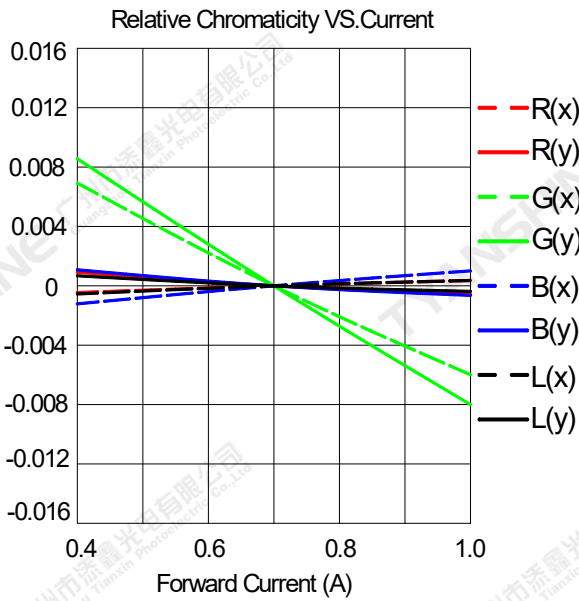

Notes: █ Red (R) ; █ Green (G) ; █ Blue (B) ; █ Lime (L) ;

Relative Spectral Distribution

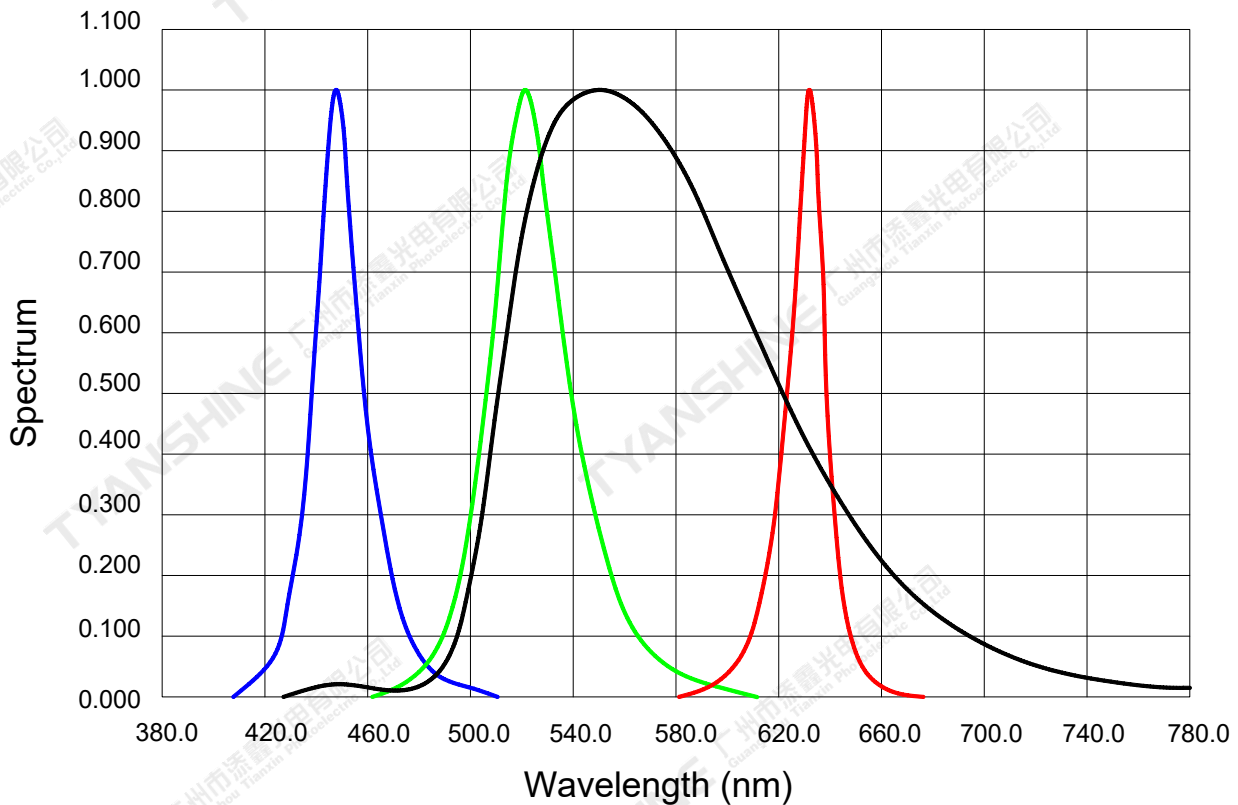

Notes:

1. $2\theta_{1/2}$ is the off axis angle from lamp centerline where the luminous intensity is 1/2 of the peak value.
2. View angle tolerance is $\pm 5^\circ$.

Usage Precautions

Storage Environment Condition

Temperature: 5°C ~ 30°C (41°F ~ 86°F)

Humidity: 60% RH Max.

Soldering Condition

Use the conditions shown to the under figure.

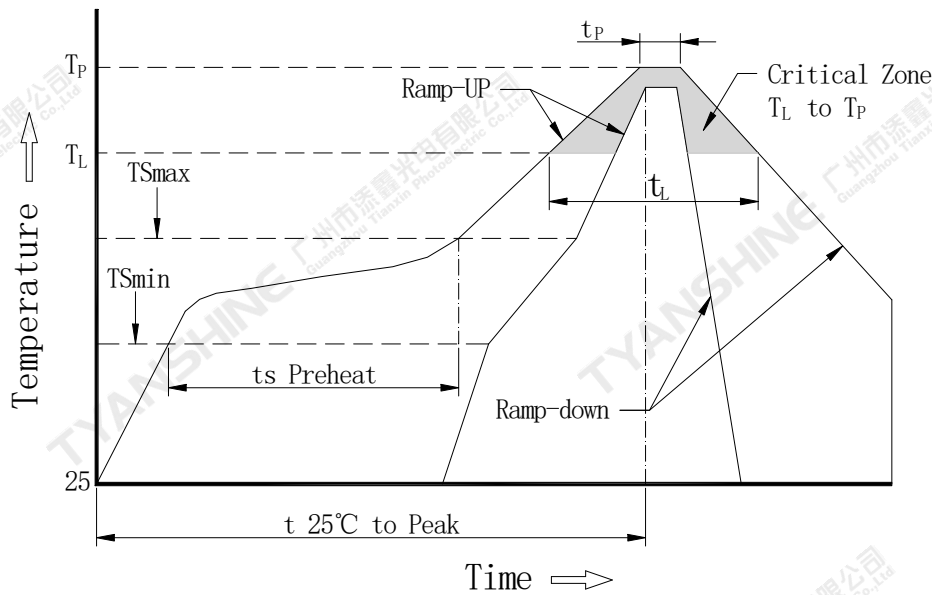

Profile Feature	Pb-Free Solder(SnBi35Ag0.3)
Average Ramp-Up Rate (TS _{max} to TP)	3°C/second max.
Preheat: Temperature Min (TS _{min})	130°C
Preheat: Temperature Max (TS _{max})	190°C
Preheat: Time (TS _{min} to TS _{max})	120-180 seconds
Time Maintained Above: Temperature (TL)	230°C
Time Maintained Above: Time (TL)	60-150 seconds
Peak/Classification Temperature (TP)	255°C
Time Within 5°C of Actual Peak Temperature (TP)	10-35 seconds
Ramp-Down Rate	5°C/second max.
Time 25°C to Peak Temperature	7 minutes max.

Note:

All temperatures refer to topside of the package, measured on the package body surface.

Dimensions For Cannulation And Packaging

Quantity: 500PCS

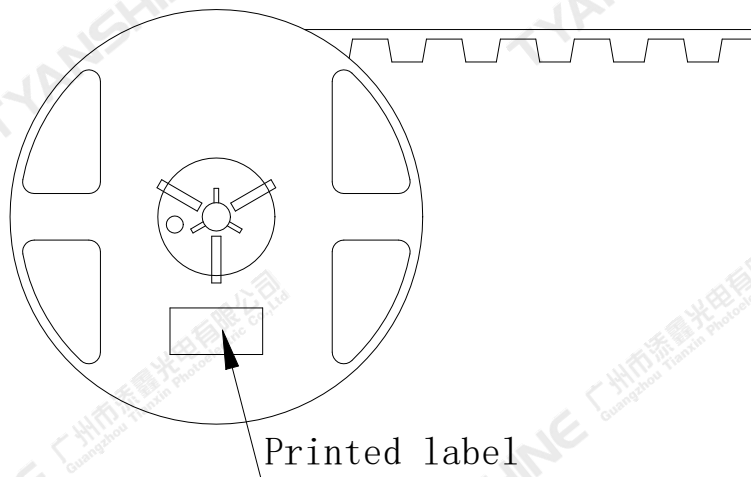
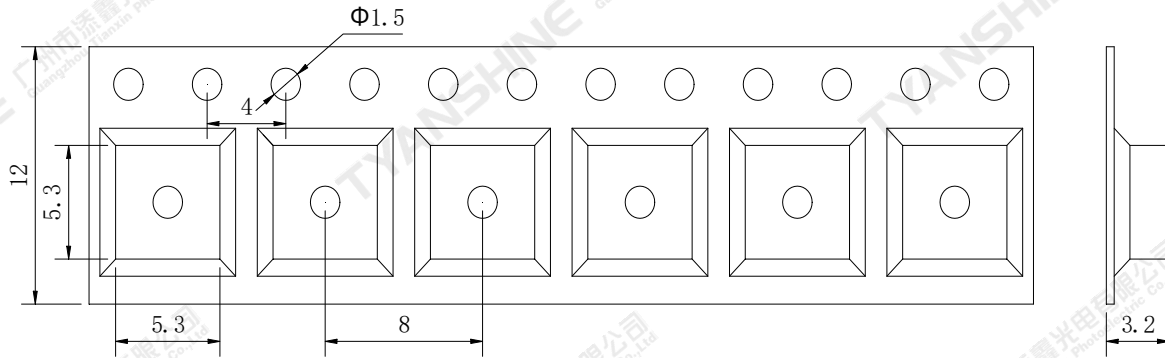

Notes:

1. All dimensions are in millimeters.
2. Tolerances are ± 2.0 mm unless otherwise noted.
3. The products are packaged together with silica gel, Transport, not to the weight of welding LED light-emitting area, As a result of the weight of LED light-emitting zone in the quality of, Irresponsible of the Company.

Part No.	TX-5050RGL10FC120-NGVCND34-02B	Spec No.	WKF-EG0030	Page	9 of 10
----------	--------------------------------	----------	------------	------	---------

