

TX-1312SW08A-2760V39-03H95

PRODUCT SPECIFICATION

Features:

- ◆ Excellent transiting heat from LED chip operating under 400mA.
- ◆ Provide uniform cross distribution of positive white and warm white dual color scheme, mixed pure.
- ◆ High luminous output.
- ◆ No UV.
- ◆ Encapsulated materials are environmentally certified and meet environmental requirements.

Chip Material:

- ◆ GaInN

Emitting Color:

- ◆ White
- ◆ Warm white

Applications:

- ◆ Commercial lighting
- ◆ General Lighting

Part No.	TX-1312SW08A-2760V39-03H95	Spec No.	WKF-DA0109	Page	1 of 5
----------	----------------------------	----------	------------	------	--------

Package Dimensions:

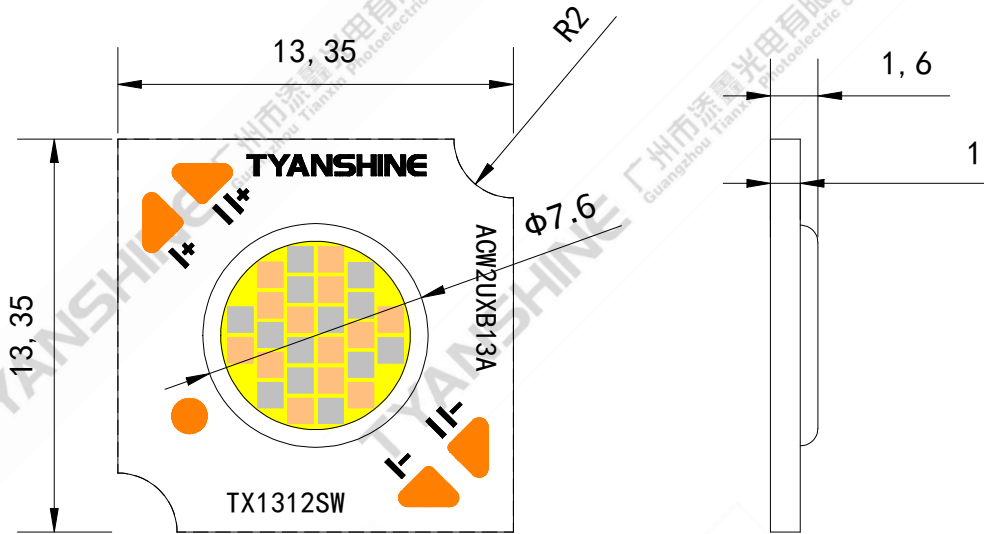

I: Warm White (S); II: White (W)

Notes:

- 1.All dimensions are in millimeters.
- 2.Tolerances unless otherwise mentioned are $\pm 0.25\text{mm}$.

Code Formats:

TX-1312SW08A-2760V39-03H95

TX	—	13	12	SW	08	A	—	2760	V39	—	03	H95
TYANSHINE	—	series	watt type	performance	LES	texture	—	CCT	VOL TS	—	BOM	Ra

Part No.	TX-1312SW08A-2760V39-03H95	Spec No.	WKF-DA0109	Page	2 of 5
----------	----------------------------	----------	------------	------	--------

Absolute Maximum Ratings

Parameter	Symbol	Ratings	Unit
Forward Current	IF	400	mA
Reverse Voltage	VR	Not designed for reverse operation	V
Power Dissipation	PD	S	16
		W	16
		S+W	16
Junction Temperature	Tj	S	150
		W	150
Case Temperature (C)	Tc	85	°C
Electrostatic Discharge Threshold (ESD)	ESD	2000	V
Storage Temperature	Tstg	-30~+100	°C
Operation Temperature	Topr	-30~+85	

Notes:

- Specifications are subject to change without notice.
- The data on this specification is for reference only and the actual data is in accordance with the acknowledgment.
- Precautions for ESD:
STATIC SHIELD Electricity and surge damages the LED. It is recommended to use a wrist band or anti-electrostatic glove when handling the LED. All devices, equipment and machinery must be properly grounded.

Electrical Optical Characteristics (Tc=25°C)

Parameter	Symbol	Condition	Emitting color	Min.	Typ.	Max.	Units
Luminous Flux	ϕ_v	If=250mA	S	650	750	—	lm
			W	850	1000	—	
Forward Voltage	V_f		S	35	37	39	V
			W	35	37	39	
Correlated Colour Temperature	CCT		S	2620	2700	2760	K
			W	5750	600	6300	
Viewing Angle at 50% IV	$2\theta_{1/2}$		S	—	115	—	Deg
			W	—	115	—	
Reverse Current	I_R		—	—	—	—	μA
Thermal Resistance Junction to Case	$R\theta_{J-C}$		—	—	2.6	—	K/W
Color Rendering Index	R_a	S	95	—	—	—	
		W	95	—	—		

Notes:

- 1.Luminous intensity is measured with a light sensor and filter combination that approximates the CIE eye-response curve.
2. $\theta_{1/2}$ is the off-axis angle at which the luminous intensity is half the axial luminous intensity.
- 3.Luminous flux measurement tolerance:±15%.
- 4.Forward voltage measurement tolerance:±3%.
5. R_a measurement tolerance:±2.

Dimensions For Cannulation And Packaging

Quantity: 36PCS

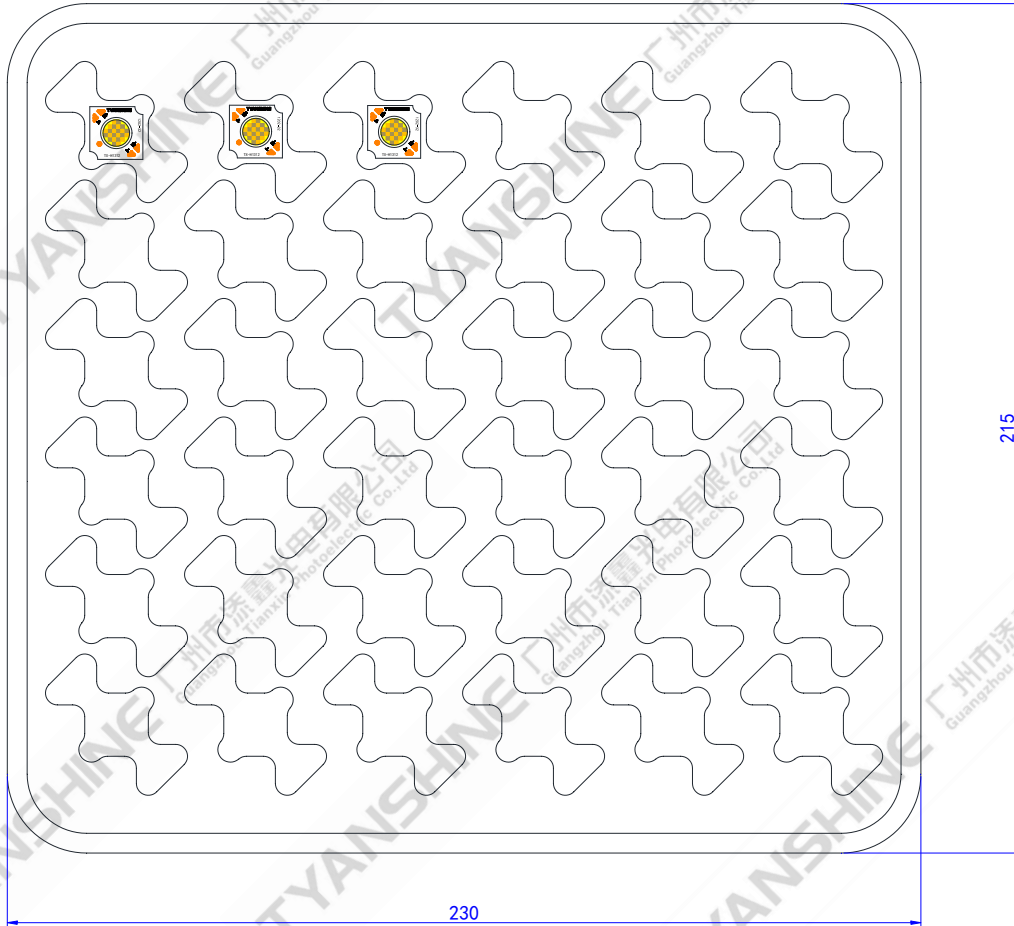

Notes:

1. All dimensions are in millimeters.
2. Tolerances are ± 2.0 mm unless otherwise noted.
3. The products are packaged together with silica gel, Transport, not to the weight of welding LED light-emitting area, As a result of the weight of LED light-emitting zone in the quality of, Irresponsible of the Company.

Part No.	TX-1312SW08A-2760V39-03H95	Spec No.	WKF-DA0109	Page	5 of 5
----------	----------------------------	----------	------------	------	--------