

TX-60350SW28A-2863V42-02H95

PRODUCT SPECIFICATION

Features:

- ◆ Excellent transiting heat from LED chip operating under 4.5A.
- ◆ Provide uniform cross distribution of positive white and warm white dual color scheme, mixed pure.
- ◆ High luminous output.
- ◆ No UV.
- ◆ Encapsulated materials are environmentally certified and meet environmental requirements.

Chip Material:

- ◆ GaInN

Emitting Color:

- ◆ White
- ◆ Warm white

Applications:

- ◆ Commercial lighting
- ◆ General Lighting

Part No.	TX-60350SW28A-2863V42-02H95	Spec No.	WKF-BF0296	Page	1 of 10
----------	-----------------------------	----------	------------	------	---------

Package Dimensions:

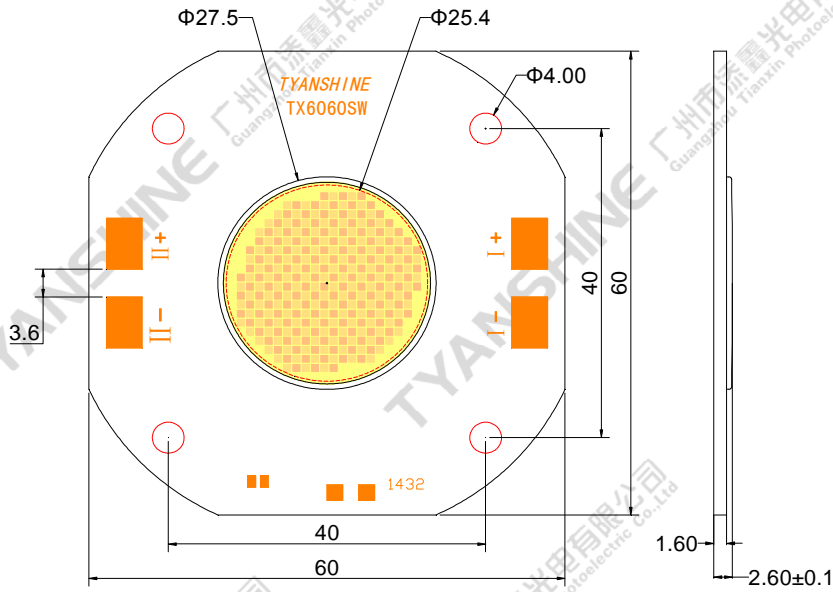

Notes:

- 1.All dimensions are in millimeters .
- 2.Tolerances unless otherwise mentioned are $\pm 0.25\text{mm}$.

Code Formats:

TX-60350SW28A-2863V42-02H95

TX	—	60	350	SW	28	A	—	2863	V42	—	02	H95
TYANSHINE	—	series	watt typ	performance	LES	texture	—	CCT	VOLTs	—	BOM	Ra

Part No.	TX-60350SW28A-2863V42-02H95	Spec No.	WKF-BF0296	Page	2 of 10
----------	-----------------------------	----------	------------	------	---------

Absolute Maximum Ratings

Parameter	Symbol	Ratings	Unit	
Forward Current	IF	4.5	A	
Reverse Voltage	VR	Not designed for reverse operation	V	
Power Dissipation	PD	W	200	W
		S	200	
Junction Temperature	Tj	W	135	°C
		S	135	
Electrostatic Discharge Threshold (ESD)	ESD	2000	V	
Case Temperature (C)	Tc	85	°C	
Storage Temperature	Tstg	-30~+100	°C	
Operation Temperature	Topr	-30~+80		

Notes:

- 1.Specifications are subject to change without notice.
- 2.The data on this specification is for reference only and the actual data is in accordance with the acknowledgment.
- 3.Precautions for ESD:
 STATIC SHIELD Electricity and surge damages the LED. It is recommended to use a wrist band or anti-electrostatic glove when handling the LED. All devices, equipment and machinery must be properly grounded.

Part No.	TX-60350SW28A-2863V42-02H95	Spec No.	WKF-BF0296	Page	3 of 10
----------	-----------------------------	----------	------------	------	---------

Electrical Optical Characteristics (Tc=25°C)

Parameter	Symbol	Condition	Emitting color	Min.	Typ.	Max.	Units
Luminous Flux	ϕ_v	If=4A	S	—	10500	—	lm
			W	—	14500	—	
Forward Voltage	V_f		S	39	41	43	V
			W	39	41	43	
Correlated Colour Temperature	CCT		S	—	2800	—	K
			W	—	6300	—	
Viewing Angle at 50% IV	$2\theta_{1/2}$		S	—	115	—	Deg
			W	—	115	—	
Reverse Current	I_R		—	—	—	—	μA
Thermal Resistance Junction to Case	$R\theta_{J-C}$		If=4A	S	—	0.1	—
		W		—	0.1	—	
Temperature Coefficient of Voltage	$V\Delta F/T$	S		—	-15	—	mV/°C
		W		—	-15	—	
Color Rendering Index	Ra	S		—	95	—	—
		W		—	95	—	

Notes:

- 1.Luminous intensity is measured with a light sensor and filter combination that approximates the CIE eye-response curve.
2. $\theta_{1/2}$ is the off-axis angle at which the luminous intensity is half the axial luminous intensity.
- 3.Luminous flux measurement tolerance:±15%.
- 4.Forward voltage measurement tolerance:±0.15V.

Part No.	TX-60350SW28A-2863V42-02H95	Spec No.	WKF-BF0296	Page	4 of 10
----------	-----------------------------	----------	------------	------	---------

Typical Electrical/Optical Characteristics Curves

(25°C Ambient Temperature Unless Otherwise Noted)

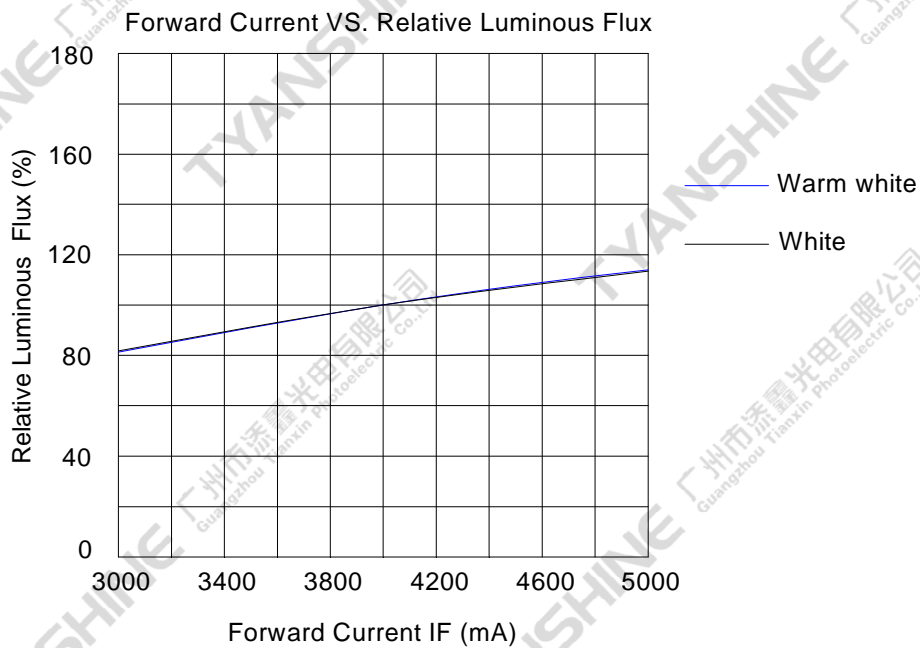
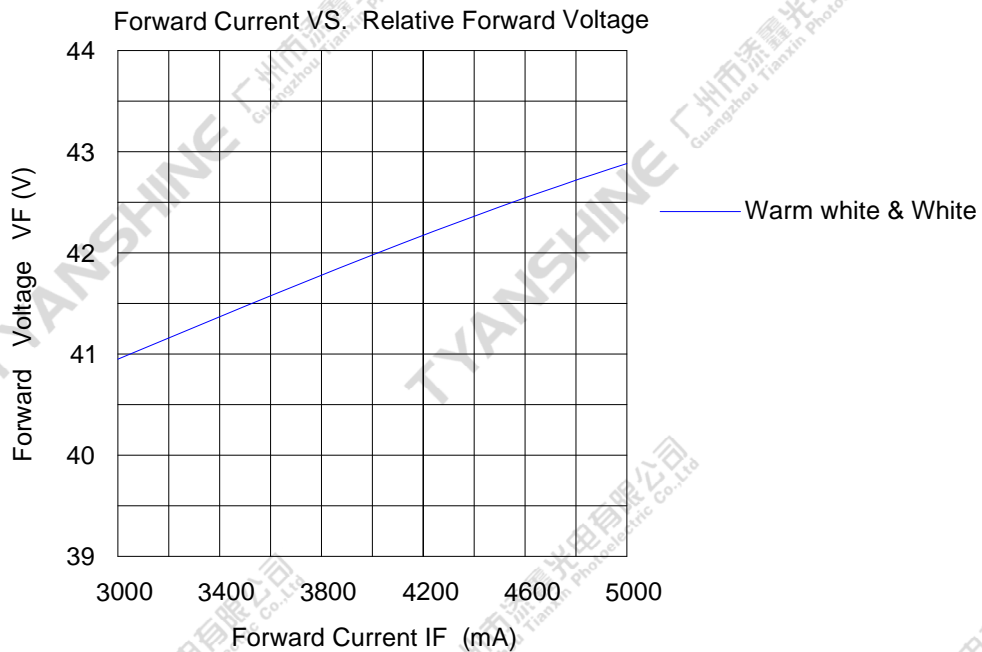

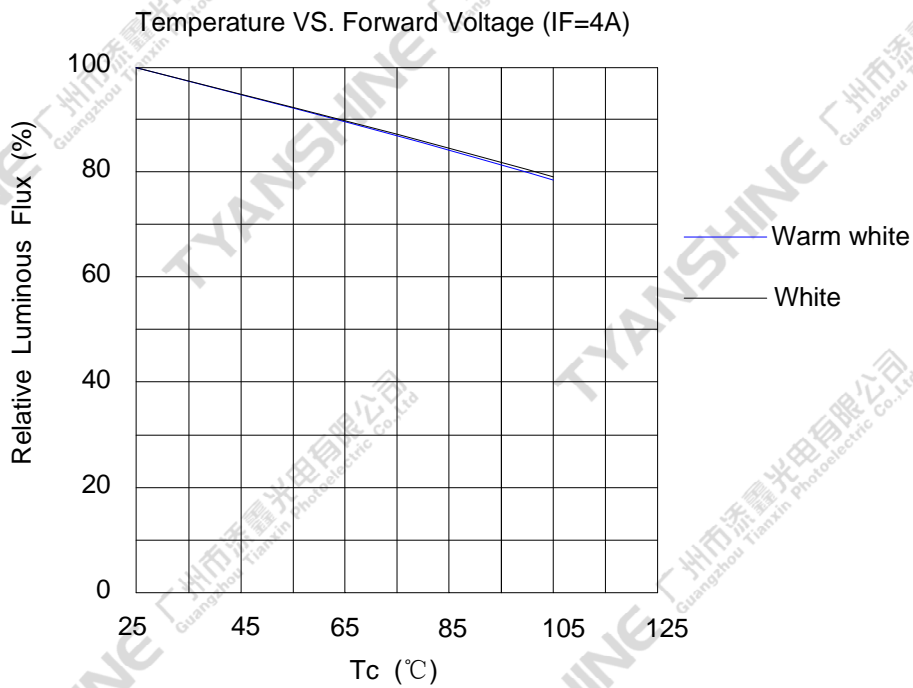
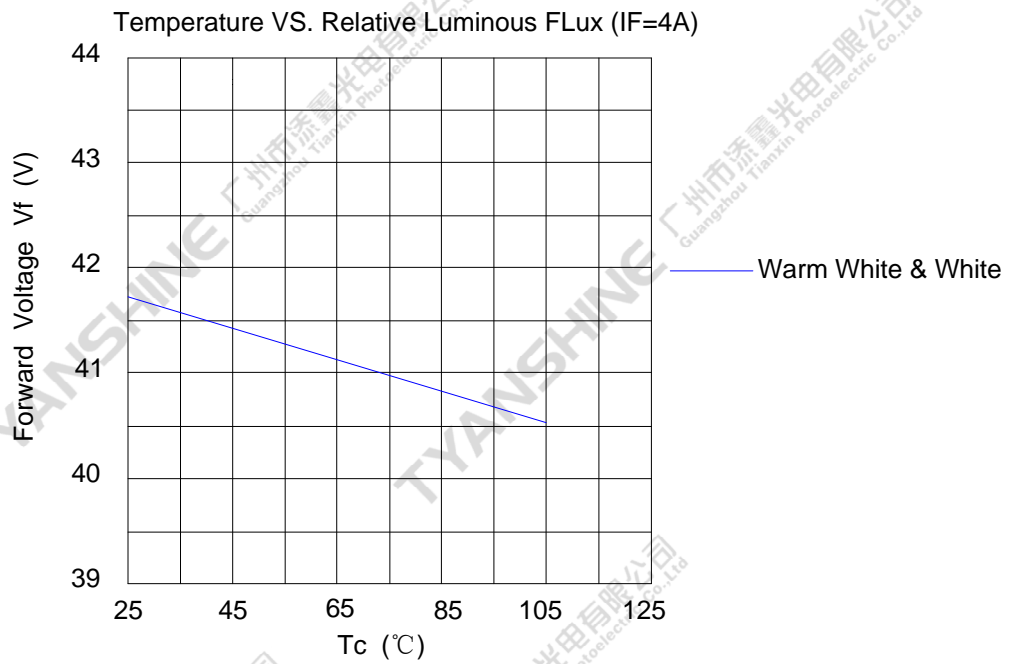

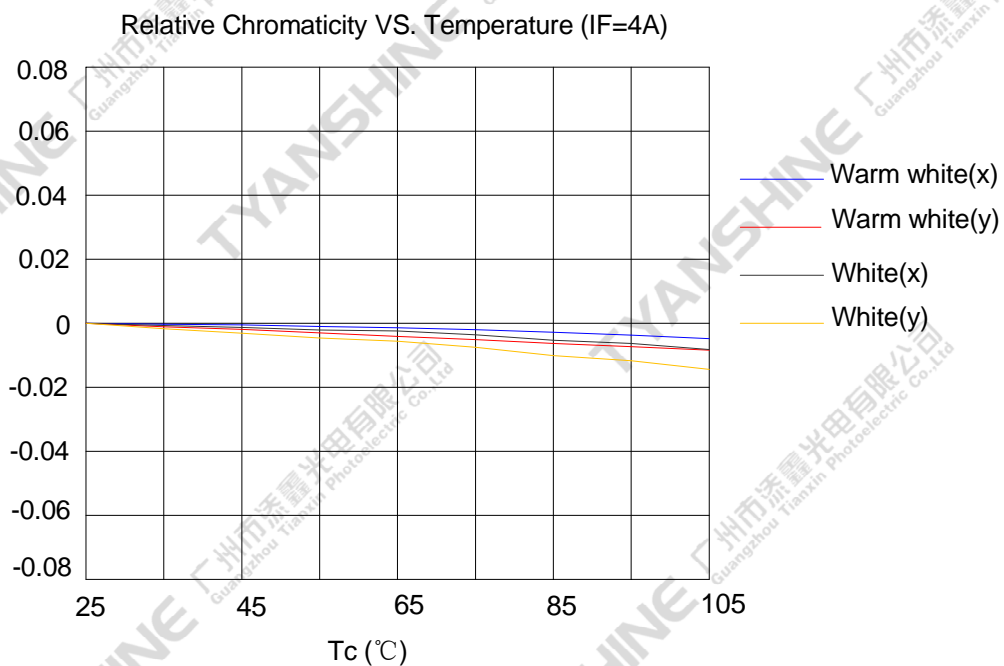
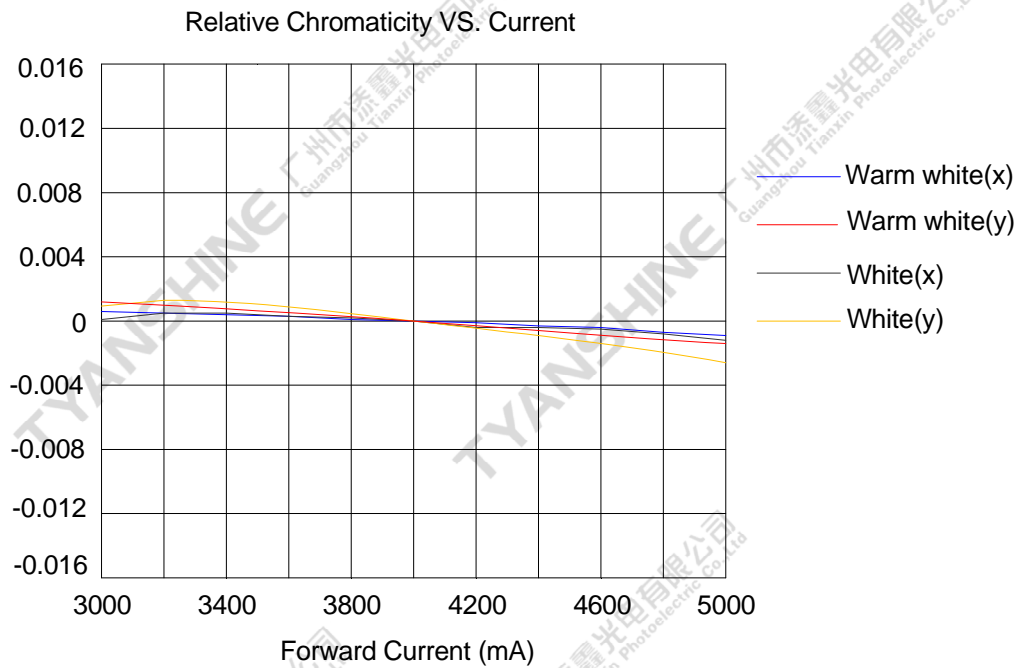

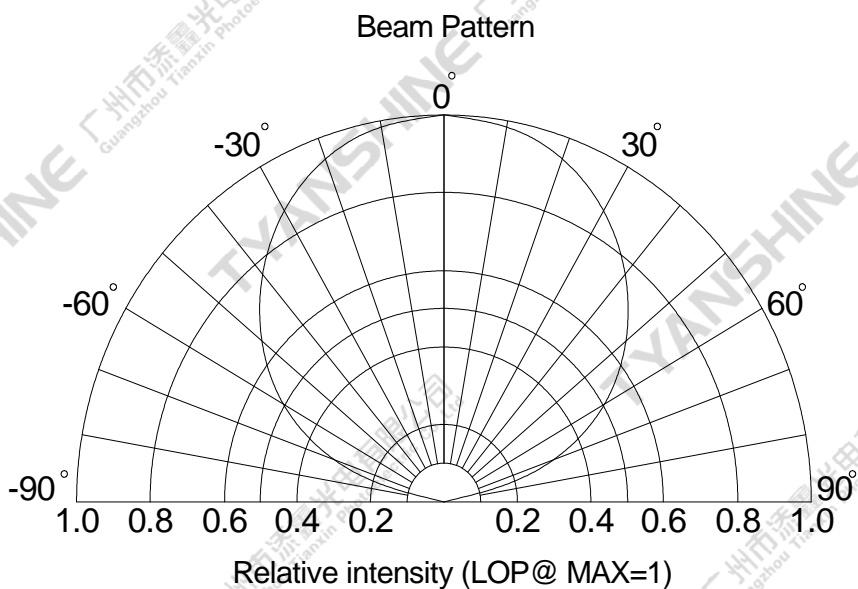
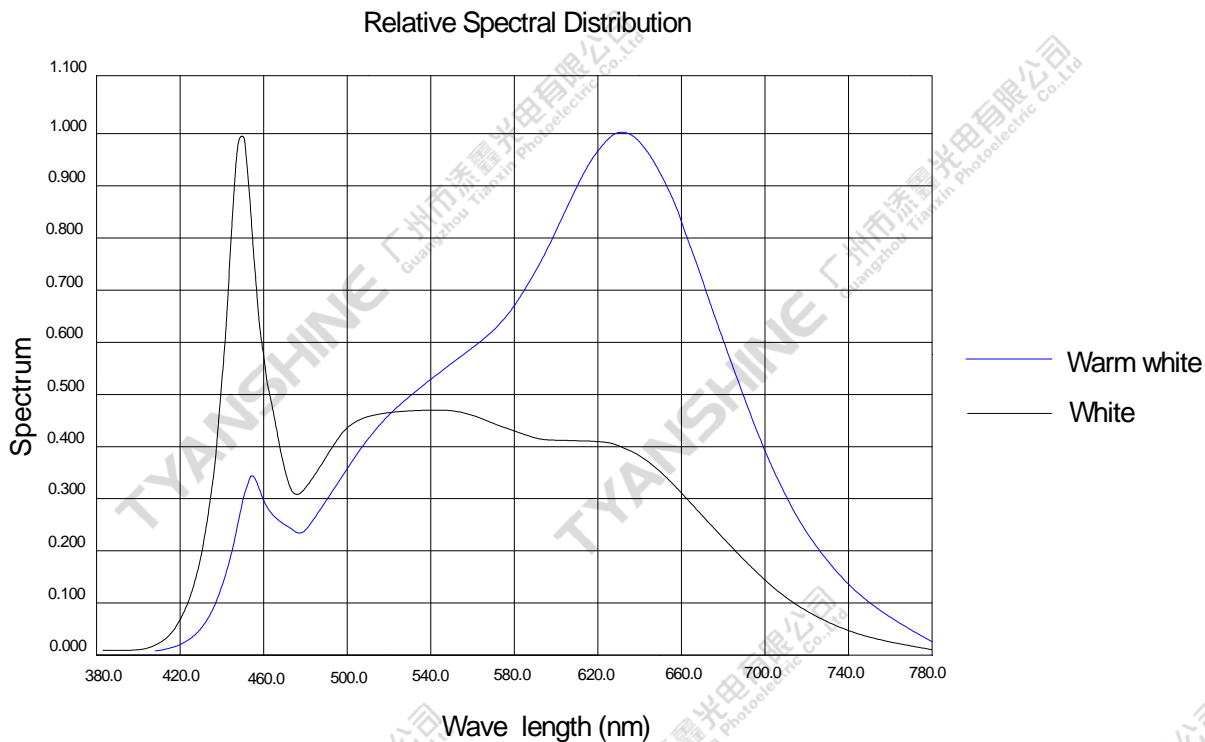

Notes:

1. $2\theta_{1/2}$ is the off axis angle from lamp centerline where the luminous intensity is 1/2 of the peak value.
2. View angle tolerance is $\pm 5^\circ$.

Part No.	TX-60350SW28A-2863V42-02H95	Spec No.	WKF-BF0296	Page	8 of 10
----------	-----------------------------	----------	------------	------	---------

Chromaticity Coordinates (Condition : IF=4A , Tc=25°C)

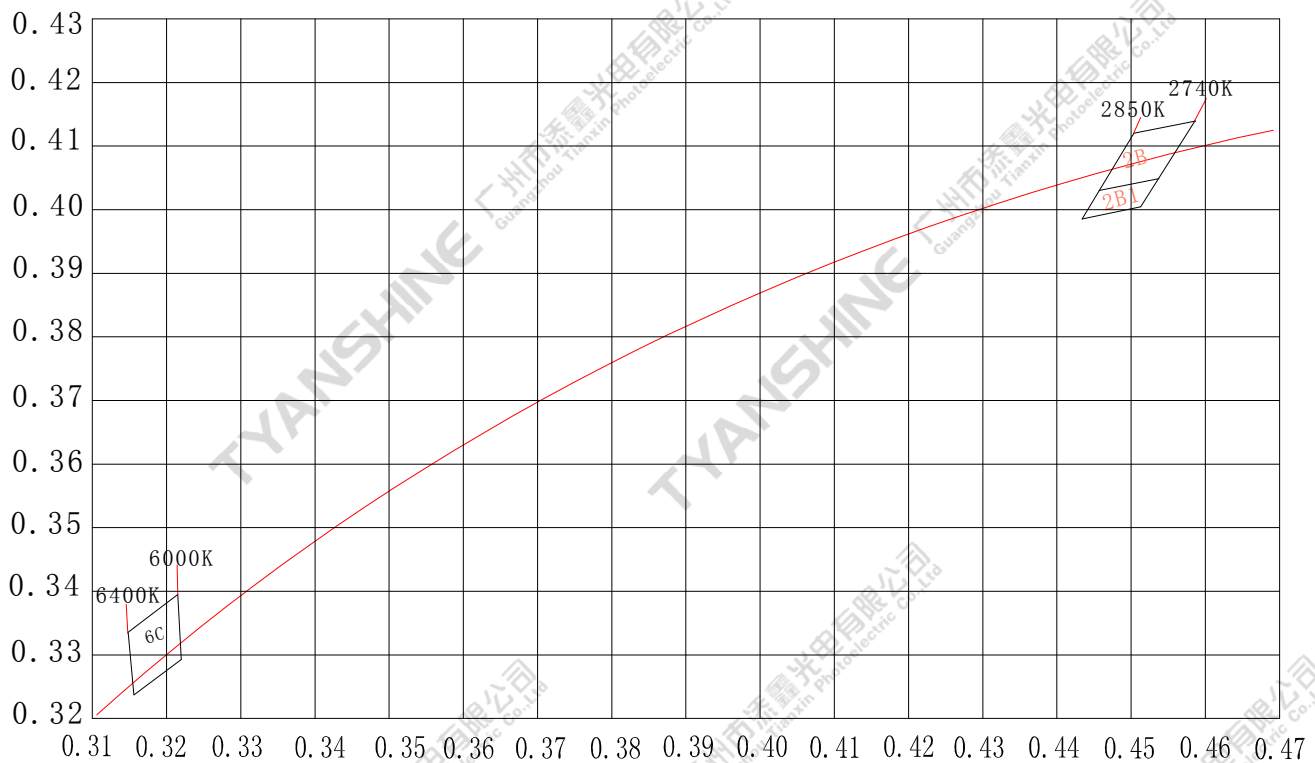

Reliability Test

Test Item	Test Condition
Continuous Operation Test	IF=4A Ta=25°C x1000hrs
Low Temperature Storage Test	-30°C x 1000 hours
High Temperature Storage Test	100 °C x 1000 hours
Moisture-proof Test	85 °C, 85 %RH for 500 hours
Thermal Shock Test	-30 °C x 30 minutes – 100 °C x 30 minutes, 100 cycle

Dimensions For Cannulation And Packaging

Quantity: 4PCS

Part No.	TX-60350SW28A-2863V42-02H95	Spec No.	WKF-BF0296	Page	9 of 10
----------	-----------------------------	----------	------------	------	---------

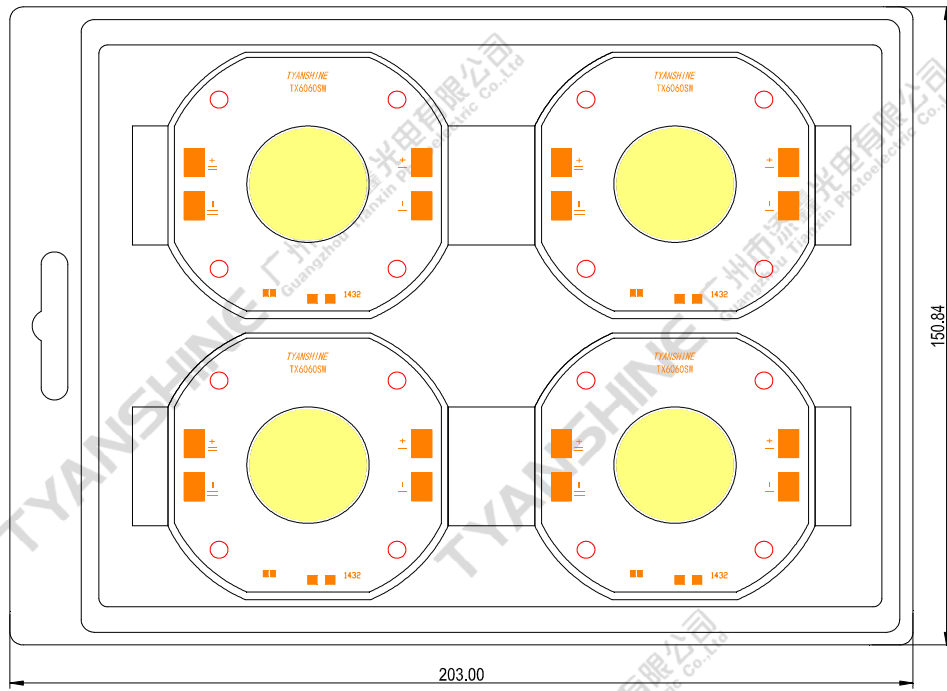

Notes:

1. All dimensions are in millimeters.
2. Tolerances are ± 2.0 mm unless otherwise noted.
3. The products are packaged together with silica gel, Transport, not to the weight of welding LED light-emitting area, As a result of the weight of LED light-emitting zone in the quality of, Irresponsible of the Company.

Part No.	TX-60350SW28A-2863V42-02H95	Spec No.	WKF-BF0296	Page	10 of 10
----------	-----------------------------	----------	------------	------	----------